

Horis - Installation and User Manual

© Kanardia d.o.o.

August 2021



Manual Revision 1.16

Software Version 3.8

Contact Information

Publisher and producer:

Kanardia d.o.o.

Lopata 24a

SI-3000

Slovenia

Tel: +386 40 190 951

Email: info@kanardia.eu

A lot of useful and recent information can be also found on the Internet. See <http://www.kanardia.eu> for more details.

Copyright

This document is published under the *Creative Commons, Attribution-ShareAlike 3.0 Unported* licence. Full license is available on <http://creativecommons.org/licenses/by-sa/3.0/legalcode> web page and a bit more human readable summary is given on <http://creativecommons.org/licenses/by-sa/3.0/>. In short, the license gives you right to copy, reproduce and modify this document if:

- you cite Kanardia d.o.o. as the author of the original work,
- you distribute the resulting work only under the same or similar license to this one.

Credits

This document was written using TeX Live (\LaTeX) based document creation system using Kile running on Linux operating system. Most

of the figures were drawn using Open Office Draw, Inkscape and QCad applications. Photos and scanned material was processed using Gimp. All document sources are freely available on request under the licence mentioned above and can be obtained by email. Please send requests to info@kanardia.eu.

Recycle

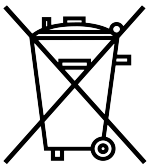

This electrical item cannot be disposed of in normal waste. Check with your local authority for kerbside collection, or recycle them at a recycling centre.

Acknowledgement

We thank Mr. John Delafield from LX Avionics UK for revising the manual. We also thank all users who pointed to the manual shortcomings and helped us to improve the manual and the product.

Revision History

The following table shows the revision history of this document.

Rev.	Date	Description
1.0	Jul 2015	Initial release.
1.1	Nov 2015	RS-232 pin description and NMEA out.
1.2	Jun 2016	Horis 80 mm.
1.3	Jan 2017	Compass, direction indicator, white line.
1.4	May 2017	Minor corrections and clarifications.
1.5	Sep 2017	Added G-Meter screen and its settings. RS232 pin 4 declared as not used.

Rev.	Date	Description
1.6	Jan 2018	Adjustable turn rate bar on AHRS screen.
1.7	Jul 2018	Added SBAS GPS symbol and a photo of broken LCD.
1.8	Sep 2018	Pinout description completed.
1.9	Mar 2019	Initial brightness and GNSS info.
1.10	Jul 2019	Roll, pitch and yaw section was added.
1.11	Dec 2019	Chrono screen was added.
1.12	May 2020	Support for special time zones and TQ-KTX2 transponder.
1.13	Jul 2020	Instrument pictures updated.
1.14	Nov 2020	Autopilot support, minor corrections.
1.15	May 2021	Internal backup battery support in Horis 57.
1.16	Aug 2021	The max output current on RS-232 port changed to 50 mA.

Contents

1	Introduction	10
1.1	Latest Manual Version	10
1.2	General Description	10
1.3	Technical Specification	11
1.4	Roll, Pitch and Yaw	11
2	Installation & Maintenance	14
2.1	LCD Display Damage Warning	14
2.2	Mounting Procedure	15
2.3	Space Behind the Panel	17
2.4	Connections	17
2.4.1	Static - Pst	19
2.4.2	Total Pressure - Ptot	19
2.4.3	CAN Bus	19
2.4.4	Power - PWR	21
2.4.5	GPS Antenna - GPS	21
2.4.6	Outside Air Temperature - OAT	22
2.4.7	RS-232 Port (NMEA Out)	24
2.4.8	D-sub 9 Port	25
2.5	Levelling AHRS	26
2.5.1	Yaw Misalignment	27
2.5.2	Procedure	28
2.6	Compass Calibration	28
2.7	Internal Backup Battery	29
2.7.1	Battery Module	29
2.7.2	Operation	30

2.7.3	Status icon	31
2.8	Maintenance	32
2.9	Repair	32
2.10	Horis Use in Gliders	32
2.11	Software Update	34
2.11.1	Update With a <i>Blu</i> Module	34
2.11.2	Update With Micro SD Card	35
3	Horis Screens	36
3.1	AD-AHRS	36
3.2	Directional Indicator	39
3.3	G-Meter	41
3.4	Chrono	42
4	Operations	43
4.1	Adjusting QNH	44
4.2	Adjusting Direction Indicator	45
4.3	Reseting G-Load	45
4.4	Setting the Neutral Pitch	45
4.5	Diminishing the Brightness	45
4.6	Settings	46
4.6.1	Units	46
4.6.2	Airspeed	47
4.6.3	Response Time	48
4.6.4	AHRS Level	49
4.6.5	Screens	50
4.6.6	Direction Indicator	51
4.6.7	G-Meter	51

- 4.6.8 Pitostatic Offset 52
- 4.6.9 Turn Rate 54
- 4.6.10 Time Zone 54
- 4.6.11 Compass Calibration 55
- 4.6.12 Compass Offset 55
- 4.6.13 NMEA Out 55
- 4.6.14 Initial Brightness 55
- 4.6.15 GNSS Info 56
- 4.6.16 Security 58
- 4.6.17 About 58

- 5 Autopilot 59**
 - 5.1 Intended Use 60
 - 5.2 Operation Limitations 60

- 6 Limited Conditions 61**
 - 6.1 Warranty 61
 - 6.2 TSO Information 64

1 Introduction

First of all we would like to thank you for purchasing our Horis device. Horis AD-AHRS is an electronic device, which includes several state of the art sensors and combines them into a small PFD display. It fits into a standard 57 mm ($2\frac{1}{4}$ ") / 80 mm ($3\frac{1}{8}$ ") panel hole. It can serve as a standalone PFD display and it may be used as primary instrument or as a perfect backup.

This manual describes the technical description of the unit, installation and operation.

CAUTION: Horis is not TSO approved as a flight instrument.

1.1 Latest Manual Version

The Horis manual changes with time. Your printed manual may be out of date. Please check our web site <https://www.kanardia.eu/product/horis/> for the latest manual version.

1.2 General Description

Horis is an electronic device. It consists of a set of sensors and an LCD display. Majority of sensors are built into its compact housing: static pressure, dynamic pressure, 3 axis accelerometer, 3 axis angular rate and GPS receiver. Only GPS antenna and OAT sensor are externally mounted. All sensors are solid state - there are no moving parts, which means less problems with fatigue and aging.

Horis has two processors: sensor processor and display processor. The sensor processor reads sensors and calculates airdata, attitude,

GPS and other values using special sensor fusion algorithms. These values are passed to CAN bus where other CAN devices may use also them. The display processor monitors the CAN bus and it displays the information on LCD display.

One push/rotate knob is used for the operations. User interface is optimized so only minimal interaction is required to operate the instrument.

1.3 Technical Specification

Tables 1–3 starting on page 12 list basic technical specifications of Horis.

1.4 Roll, Pitch and Yaw

The AD-AHRS-GPS module (a.k.a. AIRU), which is built-in Horis is responsible for calculation of roll, pitch and yaw angles (a.k.a. Euler angles).

The module holds several sensors, which readings are combined together using sophisticated algorithms. Our implementation follows ideas of Extended Kalman filtering, which combines mathematical model with measurements.

The mathematical model is based on gyroscope integration and it gives *short term* response. MEMS gyroscopes sense angular velocity. This angular velocity is integrated in time domain to obtain angles. Numerical integration is performed about 100 times per second where angular velocities are assumed to be constant between two integration steps. All MEMS gyroscopes have same error, which integrated in time quickly render angles (roll, pitch, yaw) unusable unless they are corrected with some independent measurements.

Two measurements are used to stabilize the angles. One measurement is apparent gravity. This is combination of measured values

Description	Value
Operational voltage	5 to 32 V
Operating temperature	-30 ~ +85 °C
Humidity	30 ~ 90 %, non condensing
Barometric sensor	24 bit, 10 to 1200 hPa, 20 cm resolution
QNH range	590 to 1080 hPa, (17.42 to 31.89 inHg)
Airspeed sensor	12 bit, 0 to 69 hPa, 381 km/h, 205 kt resolution < 0.1 km/h
(units before Oct 19)	0 to 50 hPa, 325 km/h, 175 kt
Acceleration	16 bit, 3D, dynamic range 0 to 16 g, typical resolution 0.12 mg
Angular rate	16 bit, 3D, 250°/s, resolution 0.009°/s
GPS	10 Hz, 66 channel, hot start 1 s, cold start 35 s, sensitivity -165 dBm
OAT	12 bit, range -55 to 125°C, 0.5°C accuracy
Communication	CAN bus, 29 bit header, 500 kbit, Kanardia protocol RS 232, NMEA out, 9600 baud (default)
Sensor processor	32 bit, ARM Cortex M3, 80 Mhz
Display processor	32 bit, ARM Cortex M3 - LCD, 120 Mhz
Start-up time	System less than 1 s, AHRS about 5 s.

Table 1: Technical specifications of Horis instrument.

from accelerometers, angular rates, true airspeed and airspeed acceleration. This apparent gravity is then used to stabilize roll and pitch angles, but it can't be used to stabilize yaw. The second measurement is the direction measurement. GPS track is used to stabilize yaw.

A combination of angular rate time integration and corrective measurements are resulting in final solution. They are combined using

Description	Value
Weight	180 g (230 g with GPS antenna and OAT cable)
Size	62 x 62 x 45 (64 with connectors) mm
Power consumption	2.16 W
Current	180 mA at 12 V
Panel hole	57 mm (2.25 inch) diameter, standard fit
Display	320 x 240 pix, diagonal 2.55", 16 bit full colour, super bright
SD card slot	micro SD, since Jan 2020

Table 2: Additional specifications for 57 mm Horis version.

Description	Value
Weight	250 g (300 g with GPS antenna and OAT cable)
Size	82 x 82 x 45 (64 with connectors) mm
Power consumption	3.2 W
Current	270 mA at 12 V
Panel hole	80 mm (2.25 inch) diameter, standard fit
Display	320 x 240 pix, diagonal 3.45", 16 bit full colour, super bright

Table 3: Additional specifications for 80 mm Horis version.

Extended Kalman filtering technique.

Although we are talking about roll, pitch and yaw angles the mathematical model does not use these angles and is using a more suitable quaternion implementation instead.



CAUTION: A coordinated flight (no slip or skid) is essential. Precision of roll, pitch and yaw is very good if such flight is maintained.

Short deviations from the coordinated flight do not represent a problem.

A long time deviation from the coordinated flight yields to false roll

and pitch. When a coordinated flight is resumed, the false roll and pitch will vanish after some time (about 30 secs).

Sustained turns do not harm the indication as long the coordinated flight is maintained. Some minor deviation is obtained in very steep turns – steeper than 50° . The main reason for this is that heading rate is so fast that GPS track is lagging behind and corrective yaw measurements are slightly incorrect. This effects all three angles.

Aerobatics will make roll, pitch and yaw useless pretty quickly as they violate coordinated flight principle. Once coordinated flight is resumed, the angles will stabilize around correct values. Typical time required is 1-2 minutes, while almost correct angles shall be established after 30 seconds.

2 Installation & Maintenance

Horis requires a standard size 57/80 mm hole in the instrument panel. Position of the hole must ensure good access for knob operations and it must be always visible from the pilot's perspective.

2.1 LCD Display Damage Warning

LCD Display can be damaged during the installation. This happens when mounting screw reaches the LCD display. We strongly advise you to use only screws provided with the instrument. Also make sure that there is *at least* 1.5 mm spacing between the screw head and Horis mask. This means that for screws provided with the instrument, minimal instrument panel thickness must be at least 1.5 mm. (This also means that even when original screws are used, LCD can be broken due to a too thin panel.) Figure 1 illustrates the danger and Figure 2 shows an example.



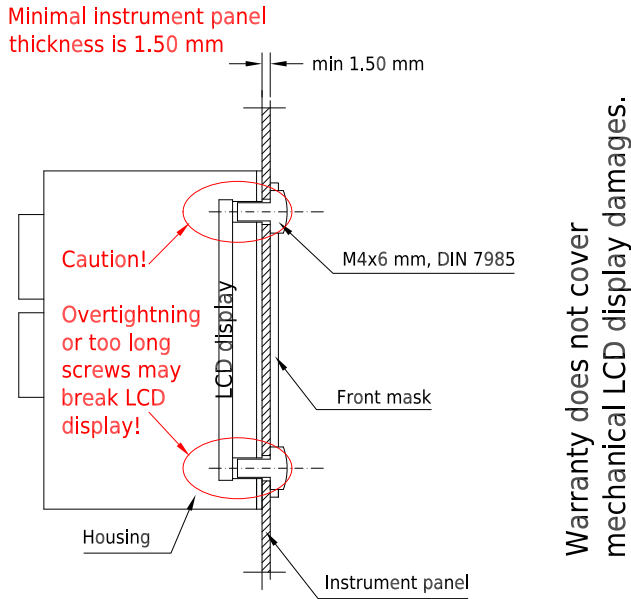

Figure 1: Screw can damage LCD screen behind the mask.

When you use your own M4 screws, please make sure that screw will never touch the LCD screen behind the front mask. Cut the screw to proper length when necessary.

2.2 Mounting Procedure

The mounting screw holes are located on a circle of 66/89 mm diameter. The instrument is mounted using three screws type M4 and one M6 insert¹. To prevent internal stresses, please make sure that the instrument panel is flat. The fourth hole is used for the knob axle. Figure 4 illustrates the mounting hole.

Remove the mounting screws from the instrument and then remove

¹ Only Horis 80 mm.



Figure 2: Example of broken LCD screen. Edge of the LCD display is visible behind the bezel.

the knob. Use finger nail or sharp knife to remove the cap from the knob, but be careful not to cut the cup away. Once the cap is removed, use flat screwdriver and loosen the screw. Slide the knob from its axle. Figure 3 shows an example of the knob with its cap removed.



Figure 3: Photo of the knob with its cap removed.

Some older Horis 80 have an additional M6 nut that is used as an axle guide. This nut must be also removed.

Insert the instrument from the back side of the instrument panel. Fix three mounting screws. In the Horis 80 case, fix also the M6 nut (axle guide). Then insert the knob back to the axle, tighten the knob. Please make sure it does not rub the panel and ensure that

it can be pushed in and out for the system operation. Put the cap back.

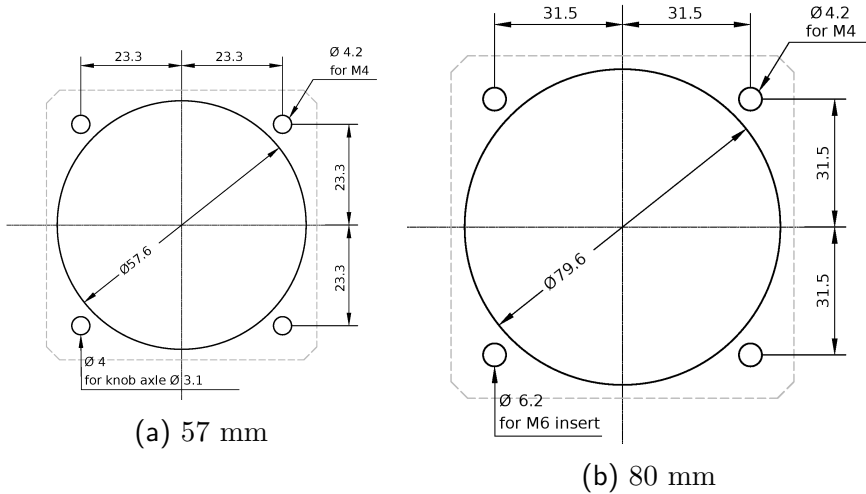

Figure 4: Instrument panel cutout and mounting holes. Some tolerance has been incorporated. Warning: Figures are not in scale.

2.3 Space Behind the Panel

Horis requires only minimal space behind the instrument panel. Depth of housing is 48 mm, connectors require additional 19 mm and cables and tubing require about 20 mm as shown on Figure 5.

2.4 Connections

Figure 6 illustrates all connections at the back side of the instrument.

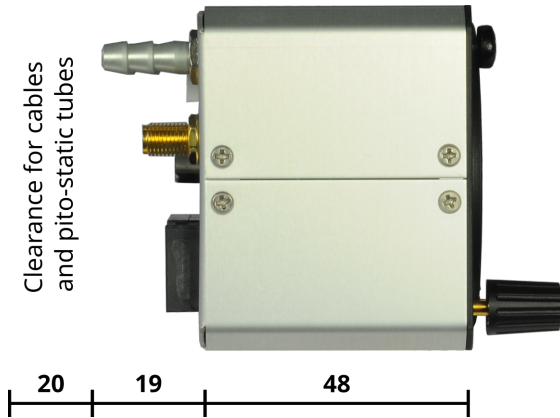

Figure 5: Side view of Horis. Only minimal space is required behind the panel. Figure shows 57 mm version, but side dimensions for 80 mm Horis are even smaller (40 mm depth).



Figure 6: Back view of the instrument with connections. 57 mm version is shown.

Horis must be connected to the pitostatic system.
AHRS will not work properly when pitostatic is not connected.

2.4.1 Static - Pst

The instrument must be connected to the static pressure source. Static source is usually obtained from pressure sources located on fuselage side surfaces or from the static port on pitot tube.

For the connection, use a tube with 4 mm inner diameter and about 8 mm outer diameter. Locate the existing tube, cut it at an appropriate place and insert a T junction. Install a new tube from junction to the instrument.

It is highly recommended to keep the static tubing as short as possible. The tubing must avoid sharp bends and twists. The tubing must be airtight. Water must not be allowed to enter the tubing.

We strongly recommend labelling each tube before connecting to Horis or any other instrument. If you ever have to remove Horis from the instrument panel, this will help a lot during re-installation.

Two standard plastic T junctions are included in the Horis package.

2.4.2 Total Pressure - Ptot

Total pressure connection comes from the pitot tube. Same principles as with static connection apply.

2.4.3 CAN Bus

Connection to the CAN bus is optional and is not required for normal operation.



When Horis is not connected to the bus, a terminator plug (Figure 7) must be inserted into one CAN connector. The terminator plug is a plain RJ45 plug with 120 Ω resistor connected across pins 4 and 5, while pins 1,2,3 and 6,7,8 are not connected.

Figure 8 and Table 4 defines the pin out of the CAN bus.

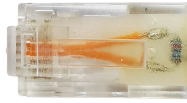

Figure 7: Terminator plug is required if nothing else is connected to Horis.

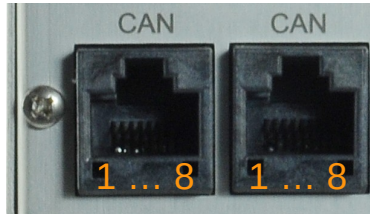

Figure 8: Illustration of the pin out of the CAN ports.

Pin	Description
1	+12V out.
2	+12V out.
3	+12V out.
4	CAN low.
5	CAN high.
6	GND – ground.
7	GND – ground.
8	GND – ground.

Table 4: Description of pins for the CAN bus communication.

When connected to the bus, Horis will transmit a large amount of information: attitude, altitude, position, temperature, baro-settings, health status etc. Slave units connected on the bus (round altimeter, airspeed indicator, etc.) are capable of using this information.

Use standard RJ45 Ethernet cable to connect Horis with other Kanardia equipment. Both connectors are equivalent.

2.4.4 Power - PWR

Connect supplied power cable at the back of the instrument. Power connector has a notch on one side, which protects against wrong polarity, see Figure 9.



Figure 9: Pins of the power connector.

Connect blue lead to negative (ground) terminal and red lead to positive (+12-24 V) terminal.

A 1 ampere slow fuse or a similar circuit breaker shall be used on the positive lead.

2.4.5 GPS Antenna - GPS

Please consider mounting GPS antenna, as follows:

- Find a good spot in a cabin where the antenna is able to see blue sky during most of the aircraft movement. Such a good spot can be usually found on the top of the instrument panel cover, just below the canopy.
- Mounting surface should be flat, clean and rigid.
- Avoid close proximity to any transmitting antennas like radio stations, transponders or any other active GPS antennas (GPS antennas may interfere each other).

- Antenna must not be covered or obstructed by metals (metals sheets, rods) or any other conductive material (like carbon fibres).
- The triangle/GPS text must point upwards, to the sky. For the installation use self-adhesive tape and fix the antenna on a rigid and clean surface. Supplied antenna is not intended to be installed on the aircraft exterior. If you need to install the antenna on the external surface, search a suitable antenna in your local avionics shop. Any 3.3 V active antenna with SMA male connector can be used.

The antenna is used as an additional stabilisation of artificial horizon and as a source for the tracking azimuth.

2.4.6 Outside Air Temperature - OAT

Outside air temperature (OAT) probe is shipped with Horis. This is a digital temperature sensor² glued inside a threaded aluminium housing. Default OAT cable length is 1.5 meters but other lengths are available on request.

OAT connector is standard RJ12 type, as shown on Figure 10. Description of individual pins is given in Table 5.

Pin	Description
1	+3.3V
2	Data
3	GND
4	Not connected

Table 5: Description of the OAT pins.

² Digital thermometer – DS18B20.



Figure 10: Pins of the OAT connector.

OAT information is required to calculate true airspeed from indicated airspeed and altitude, as well as to provide you with the outside temperature information.

In order to provide accurate measurements, OAT probe must be installed on a proper place where the probe is not exposed to the disturbing sources of heat:

- engine heat and exhaust heat,
- direct sunlight,
- heated air exited from cabin.

We also do not recommend installing the probe in the heated cabin area, since the elevated temperature in the cabin may influence the back side of the probe, though such influence is usually small.

Please follow these steps to install the OAT probe:

1. Locate a spot in the aircraft taking into account the considerations from above and drill a ϕ 8 mm hole.
2. Remove the external nut from the probe but keep the washer, internal nut and plastic insulation tube on the probe.

3. Install the probe into the hole from the interior. Guide the cable to the Horis back panel.
4. Apply some lock-tight and thread the external nut to the probe. The lock-tight is necessary to avoid losing the cap due to vibrations.
5. Tighten the internal nut so that the probe sits firmly and apply lock-tight on the nut. Do not over tight it.
6. Slide the plastic insulation tube over the exposed threads of the probe and cover as much threads as possible. Shrink the tube using hot air blower. Do not use open flame. Plastic insulation (shrink) tube also serves as thermal insulation for the sensor located in the tip.

2.4.7 RS-232 Port (NMEA Out)

Important: Instruments produced before 1.7.2016 may not have this port active.

Note: Horis 57 model produced since Jan 2020 is using different connector. See section 2.4.8 on page 25.

The RS-232 port is used for communication with other instruments. You need a standard RJ12 (6P6C) connector to connect to the port. The table 6 defines the pinout and figure 11 illustrates pin ordering and connector position.

In most cases you only connect two or three pins – pins 1-3. Pins 4 and 6 are used only when you use Horis as a power source.

By default Horis transmits NMEA GGA and RMC sentences on pin 3. In order to listen to these sentences, you need to connect pin 1 (GND) with GND on the listening device and pin 3 (TX) with the RX pin on the listening device. Default settings are 9600 baud, 8



Figure 11: Illustration of the pin out of the RS-232 port.

Pin	Description
1	GND – ground.
2	RX – receive data.
3	TX – transmit data.
4	Not used.
5	Not used.
6	+12V out – used to power some device, max 50 mA.

Table 6: Description of pins for the serial RS-232 communication.

bit data size, no parity and one stop bit a.k.a. 9600 8N1. You can choose different baud rate, but you can't change parity or stop bit.



Please note that max current output on RS-232 port is 50 mA at 12 V (0.6 W). A larger current may damage Horis. There is no short-circuit protection. If pins 1 and 6 are in short, this will damage Horis.

2.4.8 D-sub 9 Port

This port is used only on Horis 57 models produced after February 2020. It replaces the port shown on figure 11. The new D-sub 9 port has more pins and allows for more features in future.

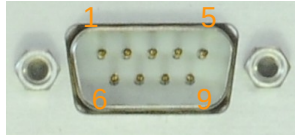

Figure 12: Illustration of the pin out on the D-sub 9 port.

Pin	Description
1	Reserved for future use, do not connect.
2	Reserved for future use, do not connect.
3	Reserved for future use, do not connect.
4	+12V out – used to power some device, max 50 mA.
5	GND
6	RS-232 RX 1 (receive line)
7	RS-232 TX 1 (transmit line)
8	Reserved for future use, do not connect.
9	Reserved for future use, do not connect.

Table 7: D-sub 9 pin description.

Currently only transmit line can be used for GPS NMEA sentences. Typically, pin 5 (GND) and pin 7 (TX 1) are connected to some receiving device.

Other pins are currently not supported by firmware and may become active with future updates.

2.5 Levelling AHRS

During assembly of the AHRS unit into the Horis and during installation of Horis into the instrument panel, a small misalignment may appear. This means that internal axes of the AHRS unit are not parallel to the aircraft axes – the AHRS unit is slightly rotated.

Such misalignment can be perfectly adjusted without loss of precision using the procedure described in this section.

2.5.1 Yaw Misalignment

Roll and pitch angle can be adjusted automatically, but yaw angle must be set explicitly, before the procedure starts.

When the instrument panel is perfectly flat and perpendicular to the airplane x-axis (longitudinal axis) than there is no yaw misalignment and the correction angle is zero. This perfect situation is illustrated on figure 13 left.

Some instrument panels are rotated regarding the airplane x-axis (longitudinal axis). In this case the misalignment angle Ψ must be measured and its value entered. Figure 13 defines positive and negative Ψ angle.

When Ψ is known, enter its value into *Yaw misalign.* item as shown on Figure 14.

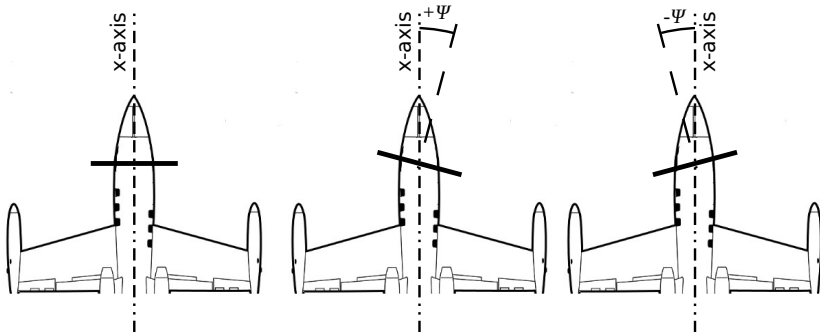

Figure 13: Top-down view illustration of possible yaw misalignment: perfect position (left), positive yaw misalignment angle (middle), negative yaw misalignment angle (right).

2.5.2 Procedure

Once the Ψ yaw angle is known, proceed with the leveling. In vast majority of cases it is safe to assume $\Psi = 0$.

- Place aircraft on flat surface and put it into cruise attitude. Use supports and lift tail or nose if necessary.
- Please make sure that aircraft is level for both, roll and pitch. Make also sure that Horis is turned on for at least five minutes – this warms up the internal electronics and stabilises numerical filters.
- Once the aircraft is level and steady, select the AHRS level option from the settings menu.
- Set the `Yaw misalign.` value first. In most cases, this value is zero.
- Then select the `Start leveling.` This will start the leveling procedure.
- Wait for the progress bar to finish and observe the roll and pitch numerical values. At the end they should stabilise. These values tell the misalignment angles and Horis will use them for the compensation. Window closes automatically.

2.6 Compass Calibration

If Magu magnetic compass is connected to Horis, then it is essential to perform the compass calibration procedure. Please refer to the Magu manual (not included here) for the compass installation and calibration procedure. The latest versions of manuals can be always found on our web site www.kanardia.eu.



Figure 14: Illustration of AHRS levelling procedure.

2.7 Internal Backup Battery

Since May 2021 Horis 57 mm could be ordered with *internal* backup battery. Horis 80 mm does not have this option yet and may be only equipped with external backup battery (UPS-L).

If Horis is ordered with internal backup battery the battery module is installed into the Horis. The battery module consists of power electronics and battery cell.

2.7.1 Battery Module

The battery module inside Horis is complete system for battery charging, protection and monitoring. Backup battery module inside Horis has its characteristics and limitations listed in Table 8. Module is using multi level protection to avoid use of battery in any situation which would damage the battery cell.



Internal battery cell specification is given in Table 9. Chemistry of the cell is based on lithium ferrophosphate and it is cobalt-free and nickel-free. This type of lithium based battery is considered much safer and it is also approved for aviation use. We are NOT using more common Li-Ion or Li-Po batteries. The main drawback of this

Description	Value
Weight (electronics+cell)	32 g
Run-time (full brightness)	1.2 h
Charge time	3 h
Min charge voltage	12.0 V
Min charge temperature	0 °C
Max charge temperature	55 °C
Min operating temperature	-20 °C
Max operating temperature	70 °C

Table 8: Horis backup battery module operating conditions.

chemistry is lower power density, so the total run-time is lower than in competition instruments.

Description	Value
Type	LiFePO4
Capacity	850 mAh
Weight	21 g
Cell voltage	3.2 V

Table 9: Internal backup battery cell specification.

2.7.2 Operation

Horis with internal battery is able to start even when external power is not present. It is started with a short press on rotating knob. Horis will start only when battery charge is sufficient.

When external power is applied to Horis it will start just like normal Horis. When external power is switched off, Horis remains powered

from internal battery as long as in-flight condition is detected or user is interacting with the knob.

If no in-flight condition is detected or if there is no user action with rotating knob, Horis will turn off after 5 minutes.

When Horis is operating on internal battery, it can be turned off by long press of 5 seconds. You can't turn Horis off, if it is powered externally.

2.7.3 Status icon

If Horis is equipped with internal battery the battery icon appears in the top-right corner of the screen. This icon is present on all pages. It indicates current battery status. Figure 15 shows two examples.

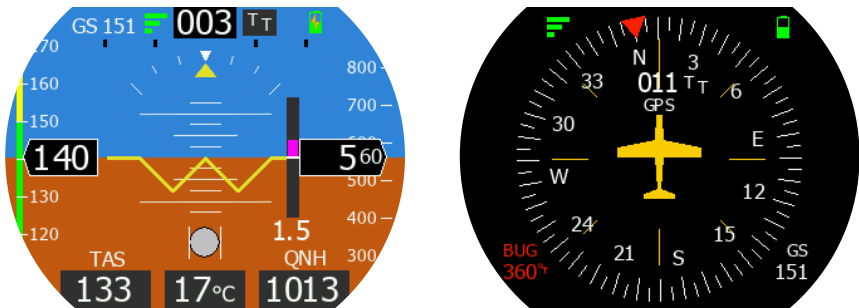

Figure 15: Battery symbol appears in the top right corner.

Battery status has several states. Each state is described with corresponding icon. Icons and their meaning are given in Table 10.



Note: When Horis does not detect internal battery presence, no battery symbol is shown. This is an error condition for cases where Horis is equipped with an internal backup battery.







	Battery full and not charging.
	Battery half full.
	Battery almost empty - less than 10%.
	Battery charging and almost full.
	Battery almost empty and charging.
	Battery is currently too cold/hot for charging.

Table 10: Battery status.

2.8 Maintenance

No special maintenance is required. A static leak test should be performed annually and calibration check biannually. In case of small deviation use the procedure described in Section 4.6.8.

2.9 Repair

Horis has no repairable parts inside. In case of malfunction it must be sent to factory for repair.

2.10 Horis Use in Gliders

Experience shows that Horis can be successfully used also in gliders. Sustained turns do not effect Horis, as long as turns are coordinated (no significant slips or skids) and even in the continuous slip case, only minor error in the bank appears.

However, low battery voltages may affect Horis operation. Although Horis works also with voltages as low as 9 V, a problem may appear even at higher voltages. A typical scenario (where gyros inside Horis go crazy) happens when battery is at its low end (say at 11 V – with



only one or two percent of capacity left). All seems to work OK until push-to-talk radio button is pressed. The radio transmission requires much more amperage (power) from the battery. For a very short time, measured in milliseconds, voltage may drop down to 3-4 V, which in turn causes instability of electronic gyros inside Horis. Unfortunately, gyros do not recover when voltage returns back to normal and hard reset (power off/on) is necessary.

This problem can be avoided in several ways.

- Most gliders use two main batteries. When Horis is needed, always fly on the battery which is more full.
- A 57 mm Horis may be equipped with internal backup battery.
- For 80 mm Horis, you can use our backup battery module, P/N: *UPS-L*. This will make sure that there is enough voltage available for Horis. See Figure 16. Please note that UPS-L has limited capacity and it can serve one Horis only.

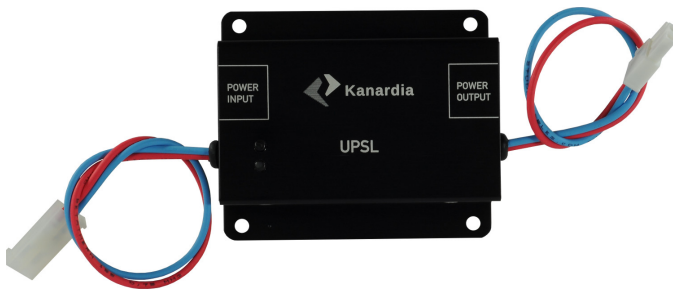

Figure 16: UPS-L – light Li-Po backup battery for 80 mm Horis..

2.11 Software Update

2.11.1 Update With a *Blu* Module

Most Horis models have no means (SD card, USB slot) for a direct software update. It can be updated with a help of the *Blu* device and an Android telephone or tablet, which is running our *Kanja* app. Blu is plugged at the back of Horis and once a communication with Kanja is established, new software is transferred to Horis and AD-AHRS module. Figure 17 shows the *Blu* module.



Figure 17: A small CAN bus to Bluetooth bidirectional interface module.

Below are step-by-step instructions for the update. Refer also to *Blu Manual* for more details.

1. Plug *Blu* device into one of free CAN ports.
2. Start the *Kanja* app on the Android device. Each time *Kanja* is started, it automatically downloads the latest firmware from our server.
3. Connect *Kanja* and *Blu* device. Once connection is established, a list of units detected on the CAN bus will appear. As minimum, *Horis* and *Airu* must be on the list. The exact list

depends on number of Kanardia instruments connected to the CAN bus.

4. Select *Horis* from the list and then select *Update*.
5. Confirm the selection – press *Yes* and Kanja will start the firmware update.
6. Once the update has been completed, press the *Back* arrow on the top left corner of the Kanja app. This brings back the device list.
7. Select *Airu* from the list and then select *Update*. This will update the AD-AHRS-GPS module, which is hidden inside the Horis. (Slave Horis does not have such module inside.) Red crosses will appear on the Horis screen during the update. This is normal.
8. Once the update has been completed and red crosses has disappeared, Kanja can be disconnected and Blu removed. New firmware is installed and ready to use.

2.11.2 Update With Micro SD Card

Only Horis models that have SD card slot can be updated this way. If Horis does not have the SD card slot, *Blu* must be used. See section 2.11.1.

1. Download the latest Horis software from our web site and copy it to the micro SD card. The filename must begin with *Horis* and it must end with *.bin*. For example, *Horis360.bin* is a valid name. 360 is used to identify version 3.6.
2. Insert the SD card into Horis and power it on. Horis will check for the presence of the SD card during boot cycle.

3. When correct file is found on the SD card, an update procedure will commence. A black/white flashing screen informs that update is in progress. It takes about 9-10 seconds to finish the update.
4. After the update, Horis displays a window telling about update success. This window is displayed only once after each successful update.

Note: Horis will not allow *downgrade*. For example, if current Horis version is 4.5, it will not accept any updates older than 4.5.

If flashing finishes after 4 seconds and the update success window is not shown, then the update file is probably corrupt. Download the file again from our web site and try again. Do not forget to use *safe remove* option after copy, before the SD card is removed from PC.

3 Horis Screens

Horis can show four different screens: AD-AHRS, Direction Indicator, G-Meter and Chrono. Please refer to section 4.6.5 on how to change the order of screens or how to enable/disable them.

Push the knob to change between screens.

3.1 AD-AHRS

Typically, the AD-AHRS screen appears as soon as Horis is powered on. The screen layout has been optimised to show all relevant flight information. Figure 18 shows the screen.

The following parameters are shown on the screen:

1. Indicated airspeed indicator shows airspeed obtained from the differential pressure sensor and the speed tape.



Figure 18: Horis AD-AHRS screen with markings.

2. GPS status signal. Three green bars indicate normal operation (3D fix). A small green diamond next to three green bars means that GPS position is further enhanced with SBAS (EGNOS, WAAS, etc.) One yellow bar indicates marginal 2D fix and a red cross of the gray bars indicates loss of signal. Note that GPS reception is not mandatory for AHRS – AHRS will function properly without it.

Ground speed is shown left of the GPS status signal after the GPS fix was obtained. (Note: GS is not shown on Figure 18.)

3. Azimuth (direction) indication. Dashes represent that azimuth was not yet established (You need to move for GPS receiver to calculate the azimuth.) Once established tracking from GPS will be shown.
4. Azimuth markings. The left letter tells which azimuth reference is used. It can be either:
 - T ... true azimuth.

- M ... magnetic azimuth.

The right letter tells the source for the azimuth. It can be either:

- T ... tracking taken from the GPS receiver.
- H ... heading taken from AHRS coupled with electronic magnetic compass³. By heading we mean direction into which nose is pointed. In case of strong wind this can be significantly different from tracking.

Default combination is TT. This means true azimuth and tracking obtained from GPS.

5. Altitude indicator is composed of altitude value and altitude tape moving in the background.
6. Rate of climb a.k.a. vario. Small bar shows climb or descent and a value on the bottom expresses it in numbers.
7. Baro correction a.k.a. QNH.
8. Outside air temperature a.k.a. OAT. Numerical value is displayed.
9. True air speed a.k.a. TAS is derived information obtained from indicated airspeed, outside air temperature and static pressure.
10. The inclinometer (slip-skid) indicator.

³ Electronic magnetic compass (Magu) is an external device and is not a part of Horis system. With Magu connected and properly calibrated, the AD-AHRS unit in Horis can determine heading and it can calculate wind direction and speed.

11. Artificial horizon with a reference line, roll arc and pitch lines. Reference line can be used for 45°turns, short roll arc dashes define 15°and 30°marks and longer dash defines 45°mark. In pitch, long line defines 10°, medium 5°and short 2.5°markings. When autopilot is active, a magenta line appears. It shows desired attitude as it is calculated by the autopilot.
12. Right: The turning rate scale. Yellow horizontal bar is used to show turning rate. Depending on settings, inner black points indicate either standard turn (3°per second), double turn (6°per second) or glider turn (12°per second). Outer black points indicate twice the turn rate of inner points.
Below: Relative wind indication arrow, wind speed and direction. This is shown only when Magu (electronic magnetic compass) is connected to CAN bus.

Some elements of the AD-AHRS screen are configurable. Please refer to Section 4.6 starting on page 46 for more details.

3.2 Directional Indicator

The Directional Indicator screen is optional and it may not be enabled by default. You have to enable it in settings. Please see section 4.6.5 on page 50 for the details.

Typically direction indicator is used as a second screen.

Figure 19 shows the screen with several important points marked.

1. The yellow line as an extension of aeroplane symbol points to current azimuth (direction). The azimuth is also shown in numeric value, followed by two letters. Their meaning is identical to description of item 4 on page 37. Below the azimuth number is also written source of the data. This can be:



Figure 19: Direction Indicator screen with markings.

- Compass when Magu is direction source or
 - GPS track when GPS track is used as direction source.
2. Heading bug is used as reference marker. Simply turn the knob to move the reference marker.

When Horis is coupled with an autopilot the bug is in sync with autopilot direction setting. When autopilot direction reference is changed, the bug will be automatically adjusted.
 3. Heading bug value is shown next to the knob. It tells current value/position of the bug.
 4. Ground speed is shown here for your convenience.
 5. GPS status in graphical form as is described in item 2 on page 37.

3.3 G-Meter

The G-Meter screen is optional and it may not be enabled by default. When not visible, it must be enabled in settings. Please see section 4.6.5 on page 50 for the details.

Typically, G-Meter is used as a third screen.



Figure 20: Horis G-Meter screen with markings.

Figure 20 shows the screen with several important points marked.

1. Scale neutral point is at 1 G and it is located exactly at 9 o'clock. Scale has green range, low and high yellow range and low and high red range. Scale span and ranges are defined in settings. Please refer to section 4.6.7 on page 51 for more details.
2. White pointer indicates current G-load on the scale. It is slightly filtered to prevent too vivid movement.

3. Min and max markers define the minimal and maximal detected G-load. In order to reset these markers, simply turn knob left or right.
4. Min and max detected G-load value together with current G-load are also presented in numeric form.

Knob rotation will reset min and max markers and values.

3.4 Chrono

The Chrono screen is optional and it may not be enabled by default. When not visible, it must be enabled in settings. Please see section 4.6.5 on page 50 for the details.



Figure 21: Horis chrono screen with markings.

Figure 21 shows the screen with several important points marked.

1. UTC time and GPS reception symbol. Horis gets time from GPS and the time will be shown only when GPS signal is available.
2. Local, sunrise and sunset times. They all depend on GPS signal as well and they are visible only when GPS signal is available. Local time requires correct time zone - see section 4.6.10 for more details.
3. Stopwatch can be used by turning the knob. Symbols on the left and right side of the stopwatch time define available actions.
 - Turn right to start the stopwatch.
 - Turn either left or right to stop for lap.
 - Turn left to reset or right to continue.

You can switch the pages even when the stopwatch is running. In this case, a stopwatch symbol appears on the top right part of each screen.

4. Flight time starts counting automatically when takeoff conditions are detected and stops when landing is detected. The time restarts with zero on next takeoff.

Note, false landings may be detected when Horis is used in a rotorcraft. A slow speed or hovering will falsely trigger landing event and flight time will reset when movement is resumed.

4 Operations

Horis is operated using a single push knob. You can do the following actions with the knob:

- Rotate the knob to change something.

- Push the knob to confirm something.
- Push the knob for a few seconds to enter a main menu⁴.

Horis does not have a *close* button. When a window is opened and editing mode is not active, a white bar appears across the window caption. This bar indicates the timeout. When the bar is full, window closes automatically.

There are only three flight operations: adjusting the QNH value, setting the neutral pitch and changing the brightness. There are more settings, but they are not accessed frequently.



Figure 22: Illustration of Horis main menu. The Pitch Reset option is the default one.

4.1 Adjusting QNH

QNH is adjusted by turning the knob when you are on AD-AHRS page. As QNH changes, the indicated altitude changes accordingly. All changes are visible on the screen.

⁴ We opt for this approach to avoid accidental activation of the main menu during flight.

4.2 Adjusting Direction Indicator

When the Direction Indicator screen is visible, the bug is set by turning the knob. Slow turning changes the bug position for one degree while quick turning moves the bug in larger steps. All changes are visible on the screen.

4.3 Reseting Min And Max G-Load Markers

When the G-Meter screen is visible simply turn the knob to reset markers. All changes are visible on the screen.

4.4 Setting the Neutral Pitch

Neutral pitch – zero pitch indication line changes with the aeroplane gross weight and flight regime. Horis allows resetting neutral pitch for the current flight regime.

- Open the main menu by pushing the knob for a few seconds. The **Pitch Reset** option is selected by default. See Figure 22.
- Push the knob once again in order to activate the option.

Horis needs a few seconds to adjust for new neutral pitch value. Do not use this function in a turbulence or in an unstable flight regime.

4.5 Diminishing the Brightness

Horis starts with a pre-defined initial brightness. Default initial brightness is 100%. If the brightness is not adequate, it can be changed using procedure below:

- Open the main menu by pushing the knob for a few seconds.

- Rotate the knob to select the **Brightness** option and push it to start the change.
- Rotate the knob to adjust the brightness to an appropriate level.
- Push the knob again to accept new value.
- Wait for the main menu to close automatically.

Initial (start-up) brightness is specified in settings. See section 4.6.14 for more details.

4.6 Settings

Horis can be configured with several options described next. The settings screen is accessed via the main menu. Figure 23 illustrates the settings menu and some of the options.

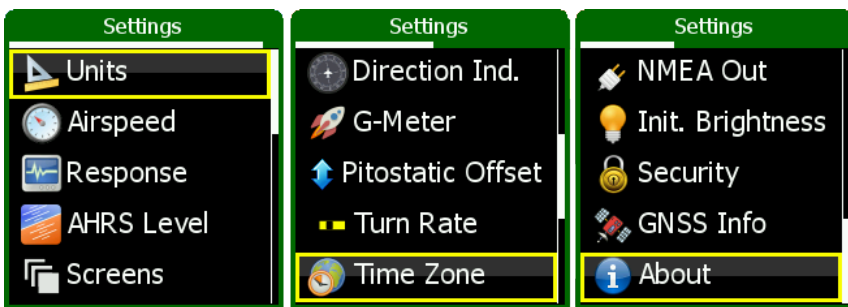

Figure 23: Horis settings menu and major options.

4.6.1 Units

This option allows fine tuning of units for almost any parameter of the main screen. Figure 24 shows the window where units may be changed. Table 11 lists all possible options.

Unit Type	Options
Heading	True, Magnetic
Speed	kts, km/h, mph
Vario (rate of climb)	m/s, ft/min, kts
Wind	m/s, km/h, kts
Altitude	meter, feet
QNH	hPa, inHg
Temperature	°C, °F

Table 11: Unit options.

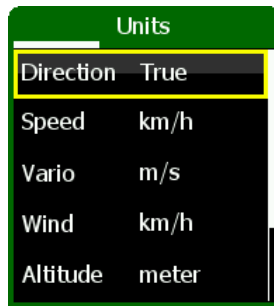

Figure 24: Units selection window.

4.6.2 Airspeed

This option is used to define the speed tape colours of the airspeed indicator. Figure 26 illustrates the window and figure 25 defines meanings of individual values on the speed tape.

The following values are used:

- **Start** defines the bottom of the speed tape. At this speed the tape starts. Typically, this is the stall speed.
- **Yellow end** defines the end of the low speed part of the yellow range. Put into another words, speeds between **Start** and

Yellow end define the bottom yellow part of the speed tape.

If you do not want to have yellow range on the bottom part, set **Yellow end** to the same value as **Start**.

- **Green end** defines the end of the green range on the speed tape.
- **VNE** defines V_{NE} (velocity never exceeded) airspeed. At this speed the yellow upper range ends and the red range begins. The red range never ends. Yellow upper range is defined automatically between **Green end** and **VNE**.

You can also mark valid extended flap position region on the speed tape. In this case you also set:

- **White start** defines the start of the white part.
- **White end** defines the end of the white part.

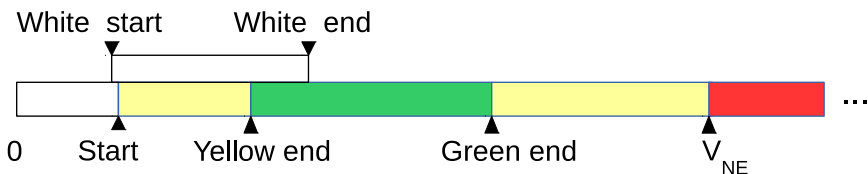

Figure 25: Definition of the speed tape colours.

4.6.3 Response Time

This option defines sensitivity of individual parameters of artificial horizon, Figure 27. Each parameter may be set to one of the following:



Airspeed [km/h]	
Start	40
Yellow end	70
Green end	150
VNE	180

Figure 26: Illustration of the airspeed window used to define the speed tape.

- **Lazy** – pretty slow response.
- **Slow** – slow response.
- **Normal** – normal response, default.
- **Vivid** – vivid response.
- **Wild** – very fast response.

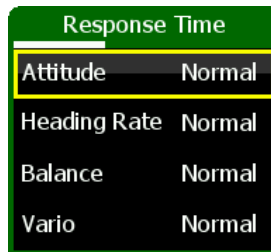

Response Time	
Attitude	Normal
Heading Rate	Normal
Balance	Normal
Vario	Normal

Figure 27: Illustration of the response time options window.

4.6.4 AHRS Level

After the installation of Horis into an instrument panel, Horis internal axes must be aligned to the aircraft axes. The **AHRS Level** procedure

is used to do this.

Selecting the **AHRS Level** option from the settings menu starts the procedure. The procedure is automatic and can't be cancelled after it has been started.

See Section 2.5 on page 26 for more details.

4.6.5 Screens

Horis may show up to four different screens. For each screen you can define its content. See figure 28. It can be one of the following options:

- AD-AHRS Screen,
- Direction Indicator Screen,
- G-Meter Screen,
- Chrono Screen,
- Empty - i.e. do not show the screen.

Optionally, you can have less screens. In this case set the screens that are not used to **Empty**.

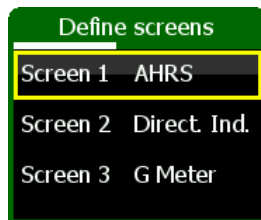

Figure 28: Illustration of screen selection.

4.6.6 Direction Indicator

Only the *Data source* parameter can be set for direction indicator. Two options are available here.

- **MAGU** – **Magu** electronic compass is used as direction source or
- **GPS track** – **GPS track** is used as direction source.

If **MAGU** is selected as direction source and **Magu** is not present, this selection will be ignored and Horis will take **GPS track** instead.

If **MAGU** is present and *GPS track* is selected as data source, magnetic compass is disabled. This option can be useful, when **MAGU** is connected to the CAN bus, but its calibration is poor or one of its sensor is defective.

4.6.7 G-Meter

The G-Meter screen can be configured with the following parameters, see also figure 29:

- **Scale** defines overall range of the scale shown on the screen. You can choose the following ranges:
 - **-2 : 4** defines low end to -2 G and upper end to +4 G.
 - **-3 : 5** defines low end to -3 G and upper end to +5 G.
 - **-5 : 7** defines low end to -5 G and upper end to +7 G.
- **Red low** defines negative G red limit.
- **Green low** defines negative G green limit.
- **Red high** defines positive G red limit.

- **Green high** defines positive G green limit.

Any valid range between green and red values is drawn in yellow color automatically.

G-Meter	
Scale	-3 : 5
Red low	-1.5
Green low	-0.5
Red high	3.8
Green high	2.5

Figure 29: Illustration G-Meter parameters.

4.6.8 Pitostatic Offset

Modern digital sensors used for IAS and altitude measurements may drift a little bit over time, especially after being exposed to a prolonged period of severe cold. Selecting the **Pitostatic Offset** option from the settings menu opens a window illustrated on Figure 30. This window allows you to change altitude and airspeed offset.

Pitostatic Offset	
Altitude Pst 980.7, Alt 273m	-0.4 hPa
Airspeed Pd: -0.03 hPa	-0.06 hPa

Figure 30: Illustration of the sensor offset window.

Altitude

In order to set the altitude offset you need a reference altimeter. Set the QNH on Horis and reference altimeter to the same value, say 1013 hPa.

- Use the knob to select the altitude offset frame. This is already selected when the window is opened.
- Push the knob to start the offset.
- Rotate the knob in order to match the altitude shown below the frame with the altitude shown by the reference altimeter. Horis shows two values: **Pst** is the static pressure and is shown in hPa and **Alt** is the altitude shown in metres. These metric units are used regardless the units selected by user.
- Push the knob to finish editing and wait for timer to close the window.

Airspeed

Important: Please make sure that aeroplane is either inside hangar or there is absolutely no wind and that pitot tube is not covered. Failing to do so may result in wrong offset and it may worsen airspeed precision.

- Rotate the knob and highlight the airspeed frame.
- Push the knob to start editing.
- Rotate the knob and observe the differential pressure value below. The differential pressure value shall read zero (or almost zero).
- Push the knob to finish editing and wait for the timer to close the window.

4.6.9 Turn Rate

Horizontal turn rate bar that appears on the AHRS screen can have different sensitivities:

- Standard $3^\circ/\text{s}$ (two minutes turn),
- Double $6^\circ/\text{s}$ (one minute turn),
- Glider $12^\circ/\text{s}$ (30 seconds turn).

This selection defines the inner dot of the turn rate bar. So, if you want to keep the correct turn rate, you have to aim to the inner dot. The outer dot defines twice the turn rate of inner dot.

4.6.10 Time Zone

Set the local time offset. Positive values are used for countries with Eastern longitudes, while Western latitudes have negative values. The time zone is defined combining two values. The first one takes whole hours and the second is an additional offset given in minutes. For most part of the world the additional offset is zero and only major offset is given.

For example, Moscow has local time defined as UTC +3h. In this case specify 3 for hours and 0 for minutes.

Another example is Adelaide, South Australia. Local time is defined as UTC+10:30. Here, set hours to 10 and minutes to 30.

Yet another one is Newfoundland and Labrador, where local time is UTC -2:30. In this case set hours to -2 and minutes to 30.

Horis does not automatically adjust for Summer daylight savings time.



Figure 31: An example of local time set for *Newfoundland and Labrador*, which is UTC - 2h 30min.

4.6.11 Compass Calibration

This option is available only when **Magu** magnetic compass is connected to the CAN bus. Please refer to the **Magu** manual for the details.

4.6.12 Compass Offset

This option is available only when **Magu** magnetic compass is connected to the CAN bus. Please refer to the **Magu** manual for the details.

4.6.13 NMEA Out

Here you can select the baudrate for the RS232 output port and the output format. 9600 bauds and *Standard* are default values, see Figure 32. Your (device) transponder may expect different speed or format. The standard format will send RMC, GGA and GSA NMEA sentences every second. The *TQ-KTX2* format will send only RMC sentence every second.

4.6.14 Initial Brightness

Use this option to set the Horis LCD display brightness at startup. Default value is 100%, but if find Horis display too bright, you may

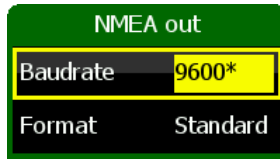

Figure 32: An example of the NMEA Out window with default values.

set it to a lower value here.

4.6.15 GNSS Info

Horis can show the GNSS satellite constellation currently in use. Figure 33 illustrates an example.

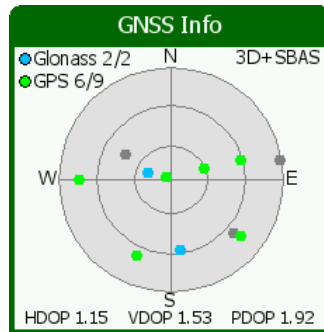

Figure 33: An example of GNSS constellation where GPS and Glonass satellites are visible. Distribution is poor. Northern latitudes are not present.

The window shows positions of the satellites on the sky. GPS constellation is represented with green dots and Glonass is represented with blue dots. All detected positions are shown. Grey color means that a satellite is being tracked, but it is not being used in solution. Under unobstructed sky, satellites should be evenly distributed.

Numbers in the top left corner tell how many of visible satellites are used in solution. For example, *GPS 6/9* means that 9 GPS satellites are detected but 6 are used in position calculation.

HDOP, VDOP and PDOP⁵ values indicates quality of the solution. The meaning of the DOP values is given in Table 12. In general, HDOP shall be always be less than 5.

DOP	Rating	Description
< 1	Ideal	Highest possible confidence level.
1 – 2	Excellent	Measurements are considered accurate.
2 – 5	Good	Still acceptable for route navigation.
5 – 10	Moderate	Position is useful, but it should be improved.
10 – 20	Fair	Measurements indicate a very rough location.
> 20	Poor	Inaccurate measurements.

Table 12: How to interpret DOP values.

Solution fix is shown in the top right corner. It can be one of the following values:

None ... there is no fix. Position is not known.

2D fix ... only 2D fix is obtained. Position measurements are poor.

3D fix ... 4 or more satellites are used in solution. Position quality should be good. See also DOP.

3D+SBAS ... 3D position is further enhanced with the SBAS system. Please refer to Wikipedia for more details on SBAS.

⁵ DOP ... Dilution of precision. HDOP ... horizontal, VDOP ... vertical and PDOP ... combined position.

4.6.16 Security

Access to the settings option of the main menu can be protected by PIN (personal identification number). By default, there is no protection and Horis does not ask for PIN.

In order to set your own PIN, select the **Security** option and enter new PIN. You have to confirm the PIN and if they match, a new PIN is set. This means that the next time you enter the **Settings** menu, Horis will ask for this PIN.

If you forgot the PIN, enter 75213 and you will get access to the **Settings** menu.

You can also set an empty PIN. In this case Horis does not ask for password.

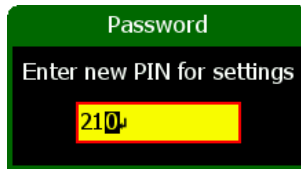

Figure 34: You can specify your own PIN to limit access to the **Settings** menu.

4.6.17 About

The About window shows some information about Horis; its serial number, software version and software creation date. In addition, it shows information about all devices connected to the CAN bus. Left of the colon is the device name and hardware version, right of the colon are software version, development version in parenthesis and serial number.

Turn the knob to see all the units connected to the CAN bus.



Figure 35: An example of the about window.

5 Autopilot

The AD-AHRS-GPS module, which is hidden inside Horis, can be used to drive an autopilot. It provides all sensor information required by autopilot. However, Horis has only one knob for all its operation, which is not enough for the required autopilot input. This shortcoming can be overcome with the help of Amigo. Together with autopilot servos they form a very neat autopilot system.

This means that the following devices are required for an autopilot system. All these devices are connected via CAN bus.

1. Horis 80 or 57 mm. It must be a master Horis. Slave Horis can not be used. The AD-AHRS-GPS module, which is inside each master Horis has all required sensors.
2. Amigo is used to operate the autopilot; to set desired direction and altitude, to setup the autopilot and to tune its parameters. It also allows quick autopilot disconnect.
3. Two servos are attached to the airplane command system.

Much more details can be found in the *Autopilot – Installation Manual*.

5.1 Intended Use

The autopilot is designed to help a pilot in stable, controllable flight conditions during cruising. If such conditions are met, the autopilot can be engaged to take some relief from the pilot, who can perhaps focus a bit more on ATC communication or to do some navigation task. Nevertheless, it is still pilot's responsibility to monitor the autopilot and airplane behavior all the time.



5.2 Operation Limitations

Always respect the following limitations.



- The autopilot shall be only used in VFR (Visual Flying Rules) conditions.
- Information from the Aircraft Operating Handbook always supersedes information given in this manual.
- The autopilot is designed to be used only in cruising conditions. It will not work at low and high speeds. It can't fly approaches and departures and it can't do takeoffs and landings.
- The autopilot shall not be used in turbulence.
- Do not use the autopilot with flaps extended.
- In any case of abnormal activity, the autopilot must be deactivated and the pilot must take over the commands immediately. Never wait for autopilot to deactivate itself automatically.
- Autopilot does not use any information from Magu (magnetic compass).

6 Limited Conditions

Although a great care was taken during the design, production, storage and handling, it may happen that the Product will be defective in some way. Please read the following sections about the warranty and the limited operation to get more information about the subject.

6.1 Warranty

Kanardia d.o.o. warrants the Product manufactured by it against defects in material and workmanship for a period of twenty-four (24) months from retail purchase.

Warranty Coverage

Kanardia's warranty obligations are limited to the terms set forth below:

Kanardia d.o.o. warrants the Kanardia-branded hardware product will conform to the published specification when under normal use for a period of twenty-four months (24) from the date of retail purchase by the original end-user purchaser ("Warranty Period"). If a hardware defect arises and a valid claim is received within the Warranty Period, at its option and as the sole and exclusive remedy available to Purchaser, Kanardia will either (1) repair the hardware defect at no charge, using new or refurbished replacement parts, or (2) exchange the product with a product that is new or which has been manufactured from new or serviceable used parts and is at least functionally equivalent to the original product, or, at its option, if (1) or (2) is not possible (as determined by Kanardia in its sole discretion), (3) refund the purchase price of the product. When a refund is given, the product for which the refund is provided must be returned to Kanardia and becomes Kanardia's property.

Exclusions and Limitations

This Limited Warranty applies only to hardware products manufactured by or for Kanardia that have the "Kanardia" trademark, trade name, or logo affixed to them at the time of manufacture by Kanardia. The Limited Warranty does not apply to any non-Kanardia hardware products or any software, even if packaged or sold with Kanardia hardware. Manufacturers, suppliers, or publishers, other than Kanardia, may provide their own warranties to the Purchaser, but Kanardia and its distributors provide their products *AS IS*, without warranty of any kind.

Software distributed by Kanardia (with or without the Kanardia's brand name including, but not limited to system software) is not covered under this Limited Warranty. Refer to the licensing agreement accompanying such software for details of your rights with respect to its use.

This warranty does not apply: (a) to damage caused by use with non-Kanardia products; (b) to damage caused by accident, abuse, misuse, flood, fire, earthquake or other external causes; (c) to damage caused by operating the product outside the permitted or intended uses described by Kanardia; (d) to damage caused by service (including upgrades and expansions) performed by anyone who is not a representative of Kanardia or an Kanardia Authorized Reseller; (e) to a product or part that has been modified to significantly alter functionality or capability without the written permission of Kanardia; (f) to consumable parts, such as batteries, unless damage has occurred due to a defect in materials or workmanship; or (g) if any Kanardia serial number has been removed, altered or defaced.

To the extent permitted by applicable law, this warranty and remedies set forth above are exclusive and in lieu of all other warranties, remedies and conditions, whether oral or written, statutory, express or implied, including, without limitation, warranties of merchantabil-

ity, fitness for a particular purpose, non-infringement, and any warranties against hidden or latent defects. If Kanardia cannot lawfully disclaim statutory or implied warranties then to the extent permitted by law, all such warranties shall be limited in duration to the duration of this express warranty and to repair or replacement service as determined by Kanardia in its sole discretion. Kanardia does not warrant that the operation of the product will be uninterrupted or error-free. Kanardia is not responsible for damage arising from failure to follow instructions relating to the product's use. No Kanardia reseller, agent, or employee is authorized to make any modification, extension, or addition to this warranty, and if any of the foregoing are made, they are void with respect to Kanardia.

Limitation of Liability

To the extent permitted by applicable law, Kanardia is not responsible for indirect, special, incidental or consequential damages resulting from any breach of warranty or condition, or under any other legal theory, including but not limited to loss of use; loss of revenue; loss of actual or anticipated profits (including loss of profits on contracts); loss of the use of money; loss of anticipated savings; loss of business; loss of opportunity; loss of goodwill; loss of reputation; loss of, damage to or corruption of data; or any other loss or damage howsoever caused including the replacement of equipment and property, any costs of recovering, programming, or reproducing any program or data stored or used with Kanardia products and any failure to maintain the confidentiality of data stored on the product. Under no circumstances will Kanardia be liable for the provision of substitute goods or services. Kanardia disclaims any representation that it will be able to repair any product under this warranty or make a product exchange without risk to or loss of the programs or data. Some jurisdictions do not allow for the limitation of liability for personal

injury, or of incidental or consequential damages, so this limitation may not apply to you.

6.2 TSO Information — Limited Operation

This product is not TSO approved as a flight instrument. Therefore, the manufacturer will not be held responsible for any damage caused by its use. The Kanardia is not responsible for any possible damage or destruction of any part on the airplane caused by default operation of instrument.